

S

**Vickers™**

No. 11-05-5071-EN-10-01

Proportional Directional Valves without Feedback



*This product has been designed and tested to meet specific standards outlined in the European Electromagnetic Compatibility Directive (EMC) 89/336/EEC, amended by 91/263/EEC, 92/31/EEC and 93/68/EEC, article 5. For instructions on installation requirements to achieve effective protection levels, see this leaflet and the Installation Wiring Practices for Vickers™ Electronic Products leaflet 2468. Wiring practices relevant to this Directive are indicated by  Electromagnetic Compatibility (EMC).*

**KBD/TG4V-3, 1\* Series**  
**Pressures to 350 bar (5000 psi)**

**We Manufacture**

**Solutions**

**Hydraulics**

hydraulic solutions

## Contents

<b>General Description</b>	Page 3
<b>Typical Section</b>	Page 3
<b>Model Codes</b>	Page 4
<b>Spool Data</b>	Page 5
<b>Functional Symbols</b>	Page 5
<b>Operating Data</b>	Page 6
<b>Power Capacity Envelopes</b>	Page 8
<b>Flow Characteristics</b>	Page 11
<b>Frequency Response</b>	Page 14
<b>Installation Dimensions</b>	
KBDG4V-3	Page 15
KBTG4V-3	Page 15
Parallel Flow Path Module	Page 16
Subplates and Mounting Surfaces	Page 16
Single Station Subplates	Page 17
Port Threads	Page 17
Mounting Surface Interface to ISO 4401 (Size 03)	Page 17
<b>Electrical Information</b>	
Block Diagram	Page 18
Typical Connection Arrangements	Page 19
<b>Application Data</b>	Page 20

## General Description

Vickers™ KB\*G4V-3 proportional valves are designed to provide controlled oil flow in proportion to an electrical command signal. They are available in two versions. Firstly a double solenoid version that will provide reversible flow and return to an actuator. Secondly a single solenoid version that provides a single direction of flow.

The KB\* valve incorporates an integral control amplifier. Factory set adjustments for gain, spool deadband compensation and dither ensure excellent reproducibility valve-to-valve.

Electrical connection is via a standard 7-pin plug and requires a power supply and command signal which can be either voltage or current (model code option).

In addition to improving machine performance and life, the KB\* proportional valves substantially simplify system design by combining direction and flow capabilities in one single package that mounts onto a standard ISO 4401 interface.

### New Features and Benefits

- State of the art digital electronic technology
- Rugged and robust die-cast housing
- Optional voltage (+/- 10 volt) or current (4-20 mA) demand input
- Adjustable ramp (0-12 sec)
- Wide range of supply voltage
- Optional external enable feature
- IP67 environmental protection
- Full CE electromagnetic capability to EN 50081-2 and EN 50082-2
- Vibration and shock tested

### Standard Features and Benefits

- Factory adjusted to ensure excellent valve-to-valve reproducibility
- Installation wiring reduced and simplified
- Wide range of spool and flow rate options
- Simple valve removal and replacement for service i.e. plug and play
- Standard 7-pin connector
- 350 bar (5000 psi) pressure rating
- Supported by auxiliary function electronic modules

## Typical Section

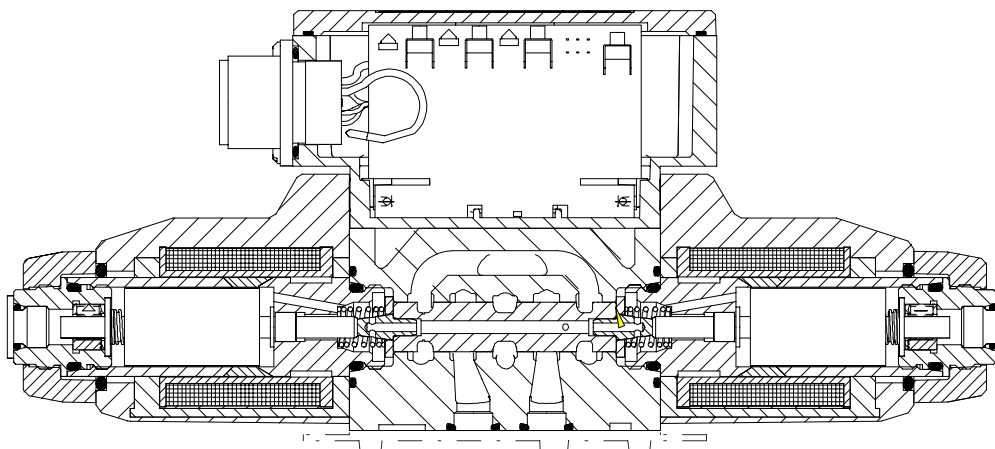

KB\*G4V-3-P\*7, 1\* Series

## Model Codes

**KB \* G 4 V 3 \*\* \* \*\* \* \*\* \* (V) M \* P\*7 H 7 10**

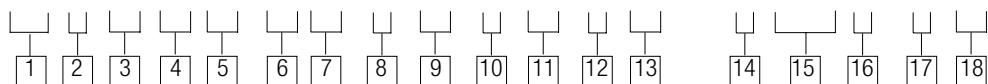

### 1 Valve Type

KB - Proportional valve with integral amplifier, B series

### 2 Control Type

D - Directional valve  
T - Throttle valve

### 3 Mounting

G - Subplate mounted

### 4 Operation

4 - Solenoid operated

### 5 Pressure Rating

V - 350 bar (5000 psi), ports P, A & B

### 6 Interface

3 - ISO 4401, size 03-02-0-94, ANSI B93.7M-DO3

### 7 Spool Type

2 - Closed center  
33 - P port closed, A & B to tank

### 8 Spool/Spring Arrangement

C - Spring centered, dual solenoid  
B - Spring centered, single solenoid (solenoid "B" version only, solenoid "A" for "V" version)

### 9 Spool Flow Rating - at 5 bar (75 psi) per metering flow path

03 - 3 L/min (0.79 USgpm)  
07 - 7 L/min (1.85 USgpm)  
13 - 13 L/min (3.43 USgpm)  
20 - 20 L/min (5.28 USgpm)  
24 - 24 L/min (6.34 USgpm)

### 10 Spool Metering Type

N - Meter-in and meter-out  
F - Fine meter-in and meter-out  
S - Meter-out only

### 11 Flow Rating for Asymmetric Flow Spools

10 - 10 L/min (2.64 USgpm) (20N10 only)  
- Omit for symmetrical spools

### 12 Manual Overrides

Blank - Plain overrides  
H - Water resistant overrides  
Z - No overrides

### 13 Solenoid Energization Identity

V - Solenoid "A" is at "A" port end, solenoid "B" is at "B" port end, independent of spool type  
Blank - US ANSI B93.9 standard (energize solenoid "A", flow is P-A)

### 14 Electrical Command Option

1 - +/- 10V control signal  
2 - 4-20 mA control signal

### 15 Electrical Connection

PC7 - 7-pin connector, without plug supplied  
PE7 - 7-pin connector, with plug supplied  
PH7 - As PE7 but with pin "C" used for enable signal  
PR7 - As PC7 but with pin "C" used for enable signal

### 16 Coil Rating

H - 24V DC amplifier supply

### 17 T port Pressure

7 - 210 bar (3000 psi)

### 18 Design Number

1\* series - Subject to change



### Warning

Valves with integral amplifiers are supplied with or without the metal 7-pin plug. The Vickers™ plug, part no. 934939, must be correctly fitted to ensure that the EMC rating and IP67 rating are achieved. The plug retaining nut must be tightened with a torque of 2-2,5 Nm (1.5-2.0 lbf ft) to effect a proper seal.

## Spool Data

### Spool Symbols

#### Available Spools for KBDG4V-3

Spool type 2C\*\*N, meter-in/meter-out

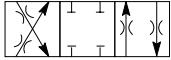

Spool type 2C20N10, asymmetric flow

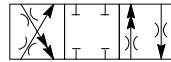

Spool Type 2C24S, meter-out only

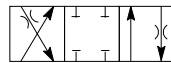

Spool type 33C\*\*N, meter-in/meter-out

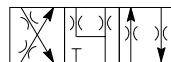

Spool type 33C20N10, asymmetric flow

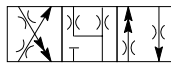

#### Available Spools for KBTG4V-3

Spool type 2B\*\*N, meter-in/meter-out

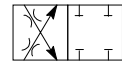

Spool type 33B\*\*N, meter-in/meter-out

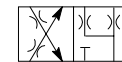

### Spool Types and Flow Ratings

#### Symmetric Spools

Base line starting at  $\Delta p = 5$  bar (75 psi) per metering flow path, e.g. B to T. For actual maximum flow refer to power capacity envelope curves.

Spool Code	Spool Symbol	Flow Rating
For KBDG4V-3 valves:		
2C03F	2C	3 L/min (0.79 USgpm)
2C07N	2C	7 L/min (1.85 USgpm)
2C13N	2C	13 L/min (3.43 USgpm)
2C20N	2C	20 L/min (5.28 USgpm)
2C24S	2C	24 L/min (6.34 USgpm)
33C03F	33C	3 L/min (0.79 USgpm)
33C07N	33C	7 L/min (1.85 USgpm)
33C13N	33C	13 L/min (3.43 USgpm)
33C20N	33C	20 L/min (5.28 USgpm)

For KBTG4V-3 valves:

2B03F	2B	3 L/min (0.79 USgpm)
2B07N	2B	7 L/min (1.85 USgpm)
2B13N	2B	13 L/min (3.43 USgpm)
2B20N	2B	20 L/min (5.28 USgpm)

#### Asymmetric Spools

Figure preceding metering type designator, "N" (e.g. 2C\*\*N) is flow rating P-A, or A-T ("A" port flow); figure after "N" (N\*\*) is flow rating P-B, or B-T ("B" port flow).

Spool Code	Spool Symbol	Flow Rating
For KBDG4V-3 valves:		
2C20N10	2C	20 L/min (5.28 USgpm), "A" port flow 10 L/min (2.64 USgpm), "B" port flow
33C20N10	33C	20 L/min (5.28 USgpm), "A" port flow 10 L/min (2.64 USgpm), "B" port flow

## Functional Symbols

#### Model Type KBDG4V-3

Proportional directional valve (with integrated electronics)

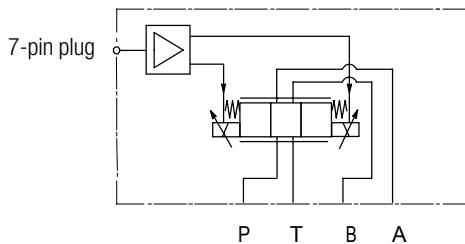

#### Model Type KBTG4V-3

Proportional throttle valve (with integrated electronics)

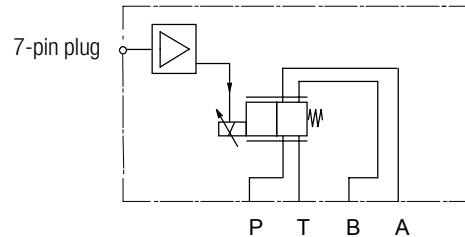

## Operating Data

KBD/TG4V-3 Valves with integral amplifier. Data is typical with fluid at 36 cSt (168 SUS) and 50°C (122°F).

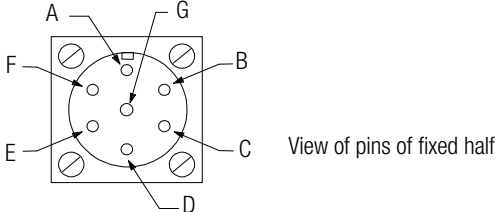
Power supply (24V) (Model code <b>16</b> H)	24V DC (21V to 36V including 10% peak-to-peak ripple) max current - 1.2A																
Command signal (Volts) Input impedance Common mode voltage to pin B (Model code <b>14</b> 1)	0 to +10V DC, or 0 to -10V DC, or -10V to +10V DC 47 kΩ 4V																
Command signal (Current) Input impedance (Model code <b>14</b> 2)	4 to 20 mA 100Ω																
Valve enable signal Enable Disable Input impedance	>9.0V (36V max) <2.0V 36 kΩ																
7-pin plug connector  View of pins of fixed half	<table border="1"> <thead> <tr> <th>Pin</th> <th>Description</th> </tr> </thead> <tbody> <tr> <td>A</td> <td>Power supply positive (+)</td> </tr> <tr> <td>B</td> <td>Power supply 0V and current command return</td> </tr> <tr> <td>C</td> <td>Valve enable (PH7 &amp; PR7)</td> </tr> <tr> <td>D</td> <td>Command signal (+V or current in)</td> </tr> <tr> <td>E</td> <td>Command signal (-V or current GND)</td> </tr> <tr> <td>F</td> <td>Output monitor</td> </tr> <tr> <td>G</td> <td>Protective ground</td> </tr> </tbody> </table>	Pin	Description	A	Power supply positive (+)	B	Power supply 0V and current command return	C	Valve enable (PH7 & PR7)	D	Command signal (+V or current in)	E	Command signal (-V or current GND)	F	Output monitor	G	Protective ground
Pin	Description																
A	Power supply positive (+)																
B	Power supply 0V and current command return																
C	Valve enable (PH7 & PR7)																
D	Command signal (+V or current in)																
E	Command signal (-V or current GND)																
F	Output monitor																
G	Protective ground																
Electromagnetic compatibility (EMC): Emission (10 V/m) Immunity (10 V/m)	EN 50081-2 EN 50082-2																
Monitor signal (pin F) KBD valves Output impedance	0 to +5V (0.39 V/A 24V power supply) 10 kΩ																
Step input response with flow through P-A-B-T Δp=5 bar (75 psi) per metering path, e.g. P-A Required flow step for 24V (H) version: 0 - 100% 100% - 0 +90% to -90%	Time to reach 90% of required step: 26 ms 35 ms 40 ms																
Reproducibility, valve-to-valve (at factory settings): Flow at 100% command signal	≤5%																
Protection: Electrical Environmental	Reverse polarity protected IEC 529, Class IP67																
Ambient air temperature range for full performance Oil temperature range for full performance	0°C to 70°C (32°F to 158°F) 0°C to 70°C (32°F to 158°F)																
Minimum temperature at which valves will work at reduced performance	-20°C (-4°F)																
Storage temperature range	-25°C to +85°C (-13°F to +185°F)																
Supporting products: Auxiliary electronic modules (DIN-rail mounting): EHA-CON-201-A2* Signal converter EHD-DSG-201-A-1* Command signal generator EHA-RMP-201-A-2* Ramp generator EHA-PID-201-A-2* PID controller EHA-PSU-201-A-10 Power supply	See catalog 2410A See catalog 2470 See catalog 2410A See catalog 2427 See catalog 2410A																

Operating Data (cont.)

Ramp time	0-12 sec for full step input (0-100%)
Relative duty factor	Continuous rating (ED = 100%)
Hysteresis with flow through P-A-B-T	<8% of rated flow
Mass: KBDG4V-3 KBTG4V-3	2,7 kg (5.9 lb) approx. 1,9 kg (4.2 lb) approx.

Power Capacity Envelopes

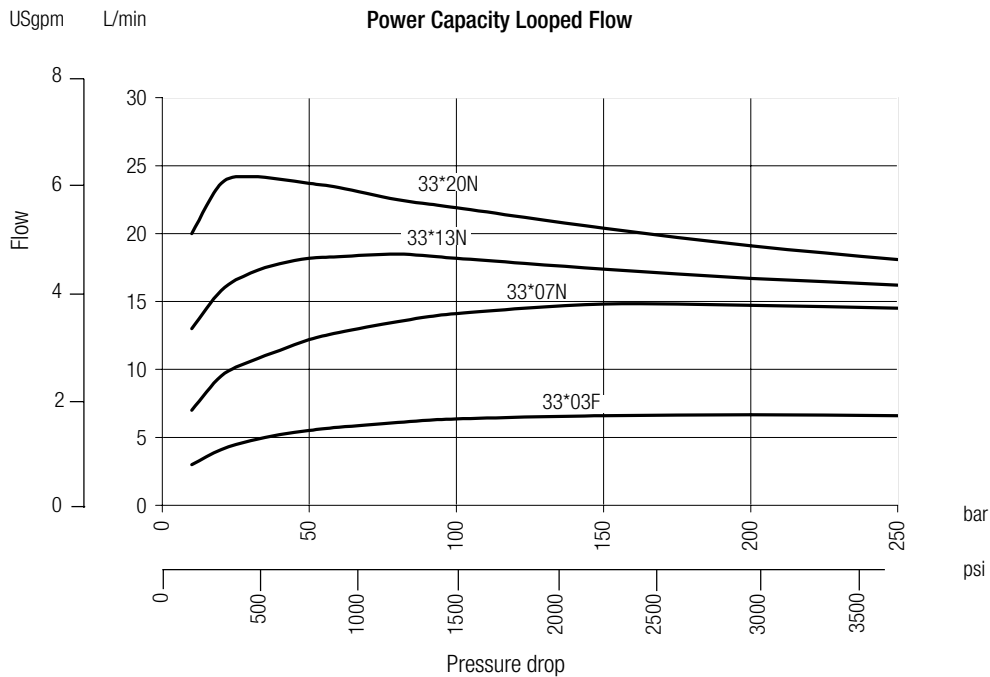
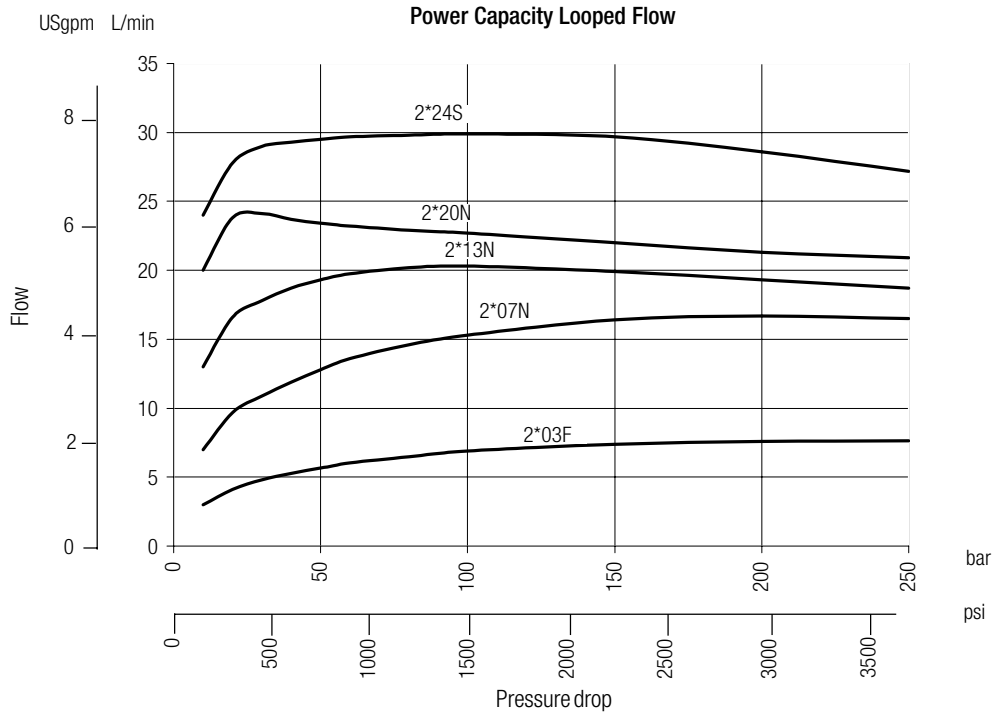



Power Capacity Envelopes (cont.)

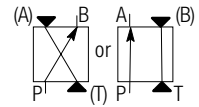
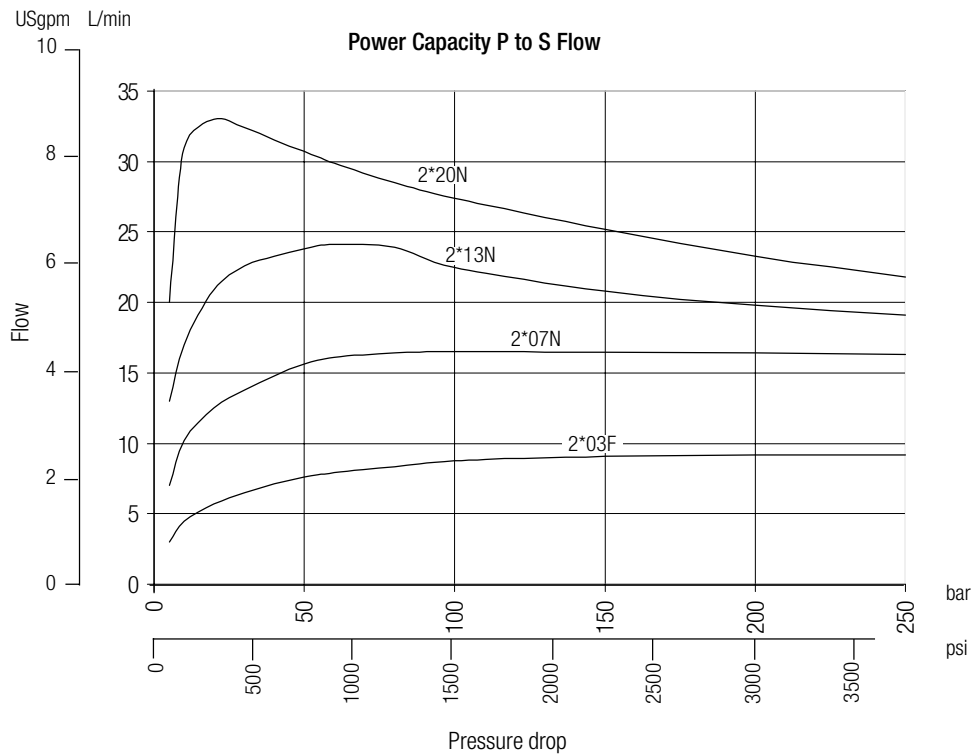
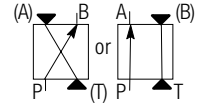
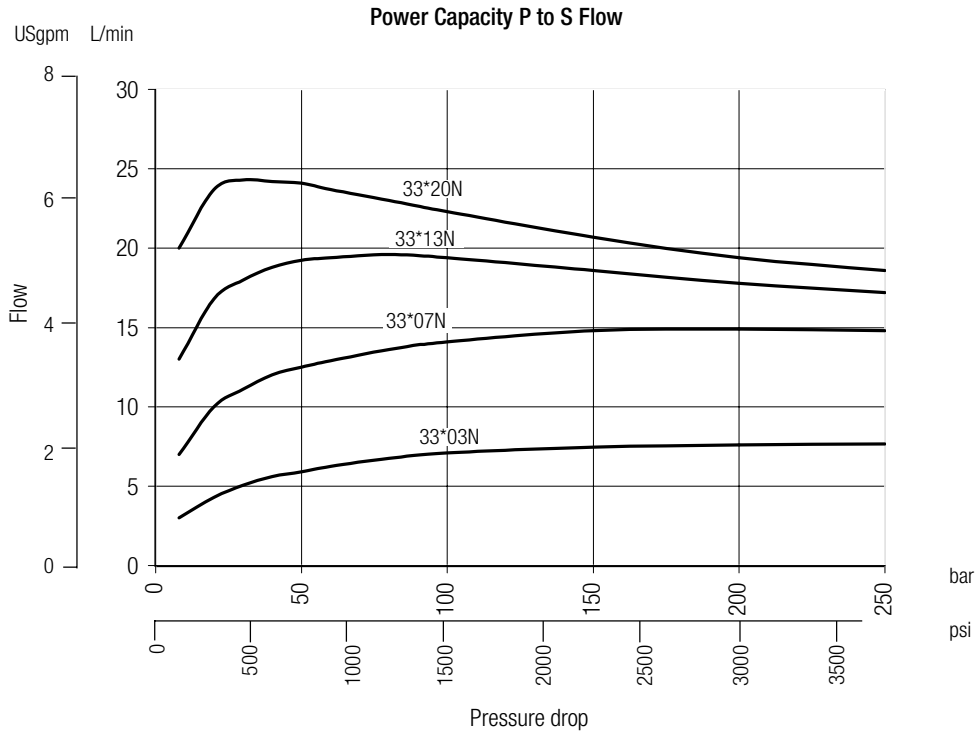

Power Capacity Envelopes (cont.)

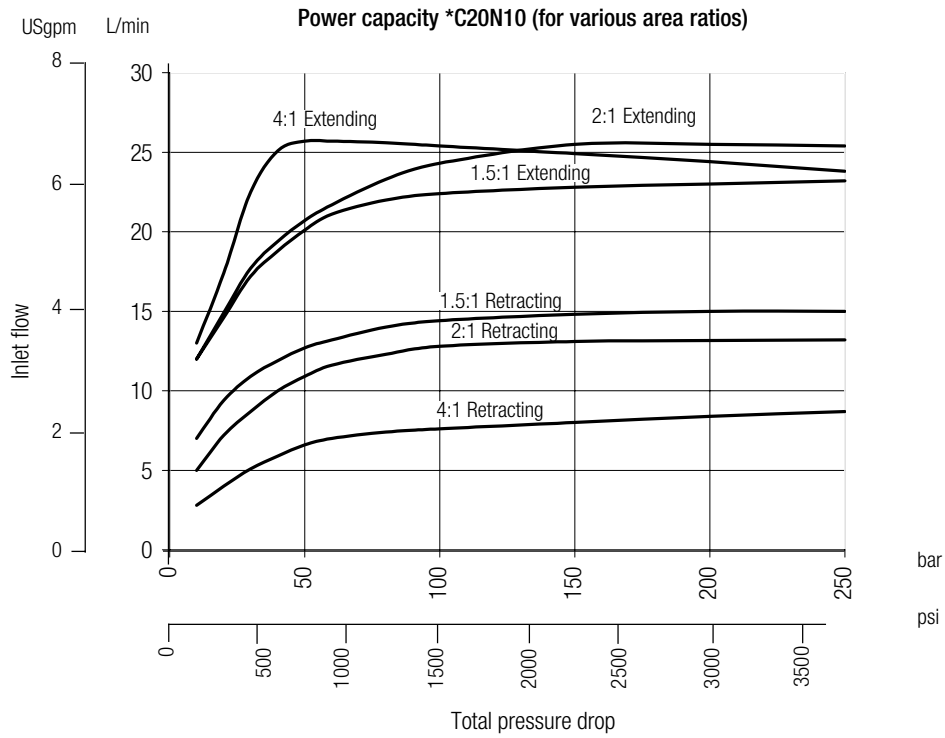

Flow Characteristics

KBD/TG4V-3  
 Spool types as noted

KB valves are preset at the factory to compensate for the effect of spool overlap.

Looped flow at  $\Delta p = 10 \text{ bar (144 psi)}$

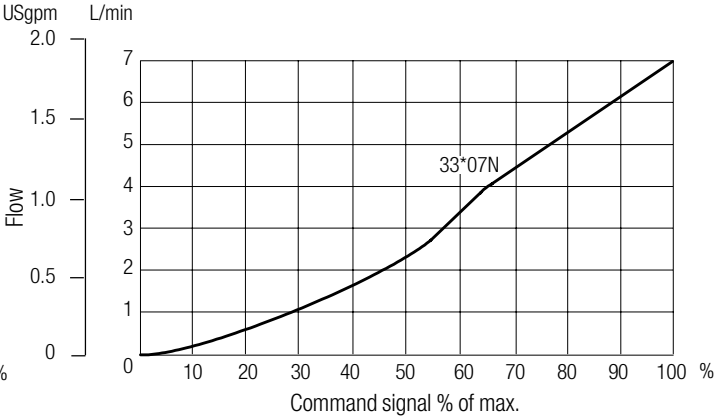
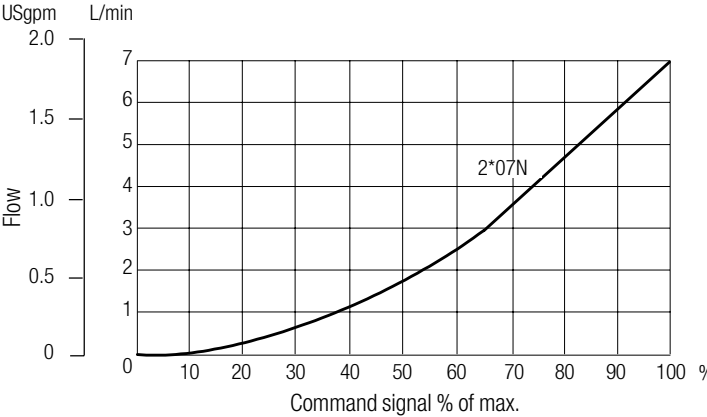
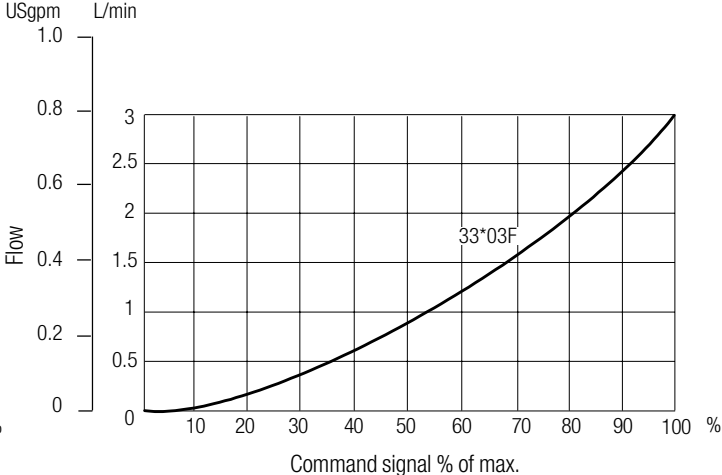
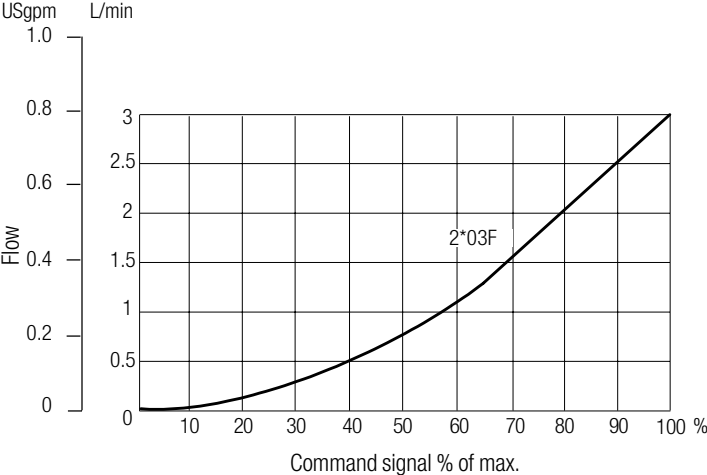

## Flow Characteristics (cont.)

KBD/TG4V-3

Spool types as noted

Looped flowpath at  $\Delta p = 10 \text{ bar (144 psi)}$

KB valves are preset at the factory to compensate for the effect of spool overlap.

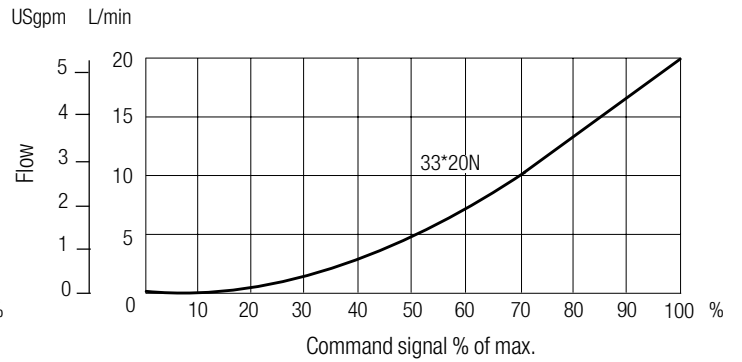
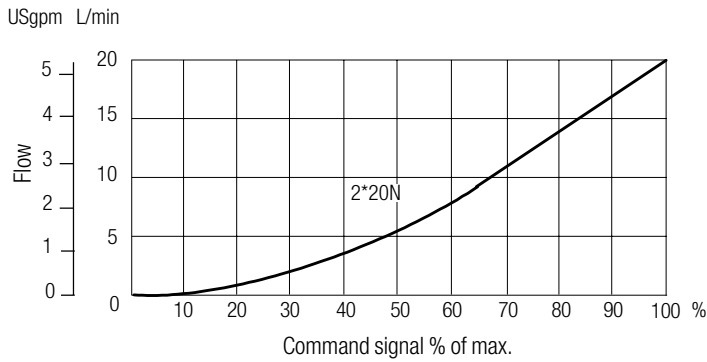
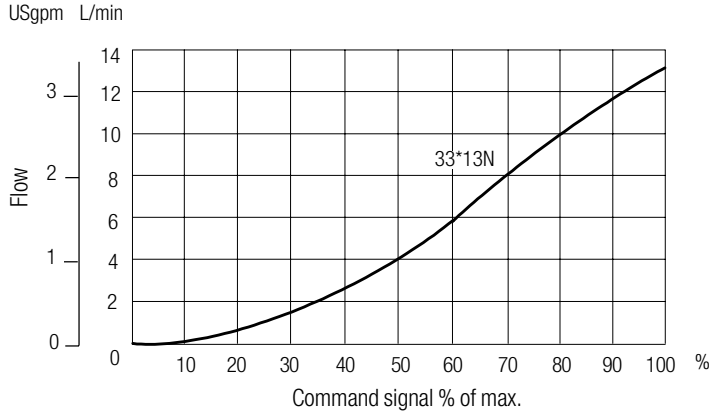
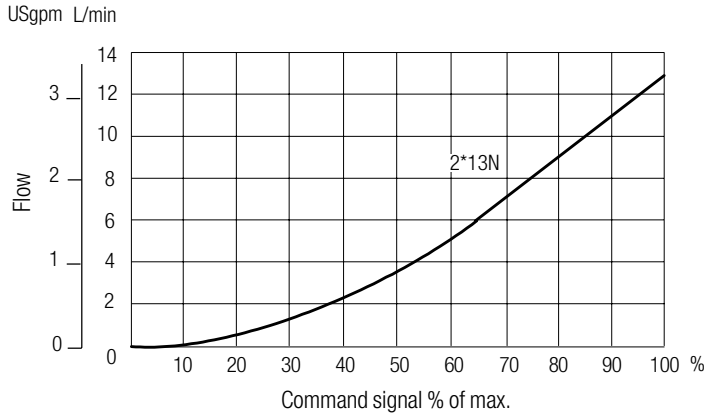

## Flow Characteristics (cont.)

**KBD/TG4V-3**  
**Spool types as noted**

KB valves are preset at the factory to compensate for the effect of spool overlap.

Looped flowpath at  $\Delta p = 10 \text{ bar (144 psi)}$

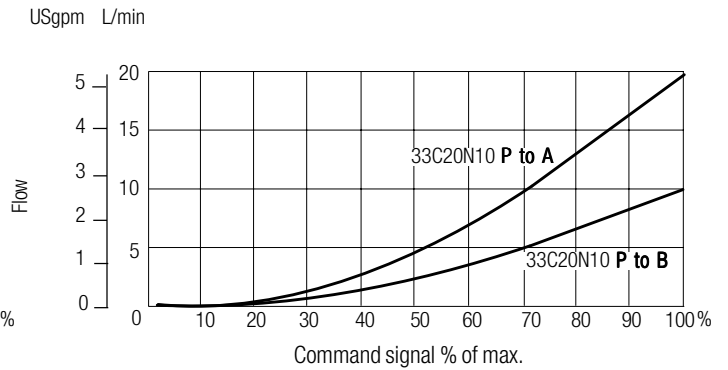
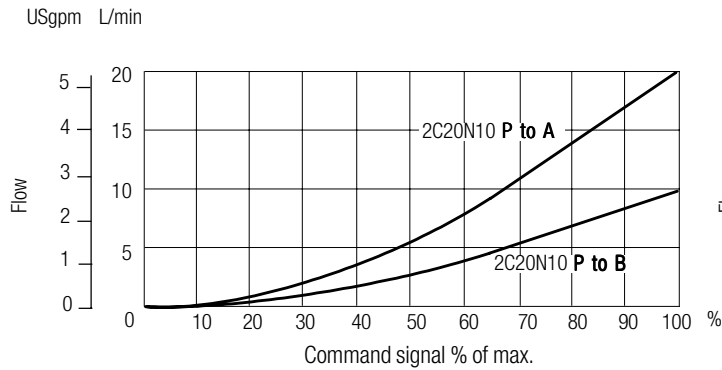
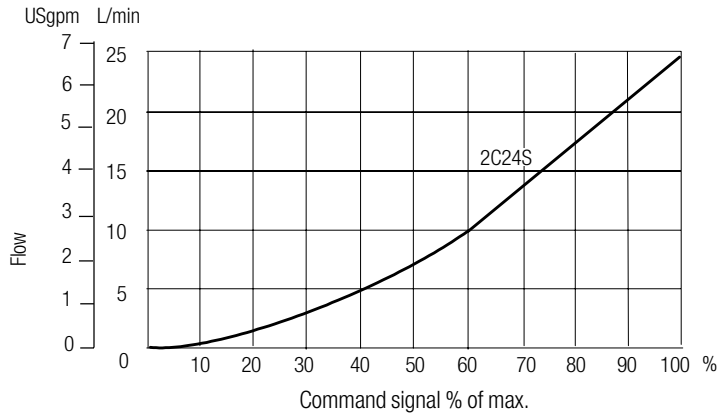

## Frequency Response (Typical)

For an amplitude of  $\pm 25\%$  max. stroke about the 50% position, at  $\Delta p$  (P-B) = 5 bar (75 psi)

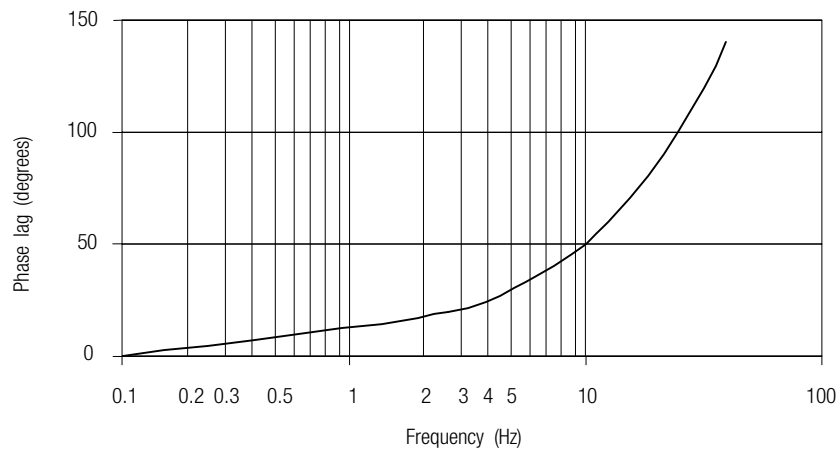
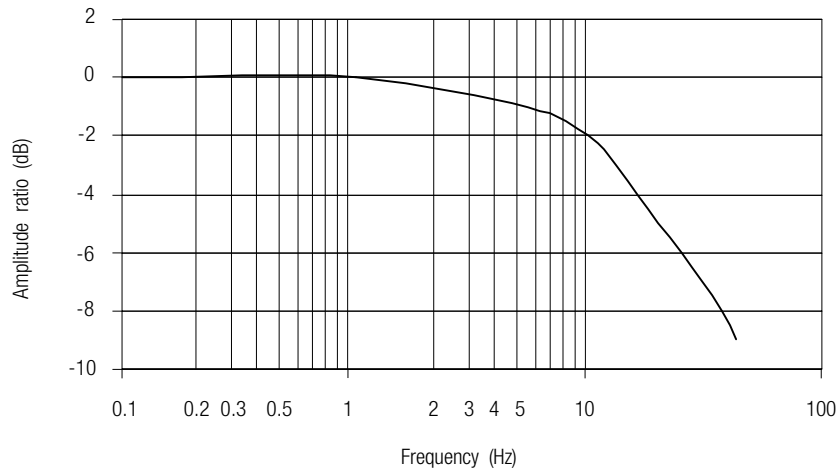

## Installation Dimensions in mm (inches)

### KBDG4V-3

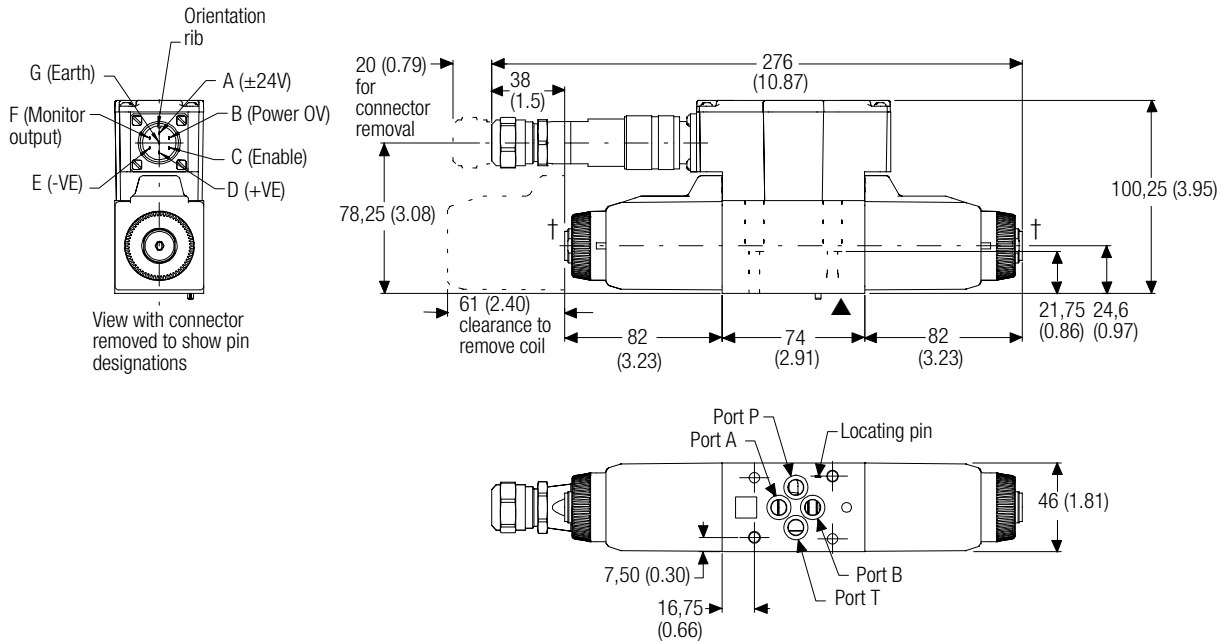
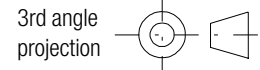

### KBTG4V-3

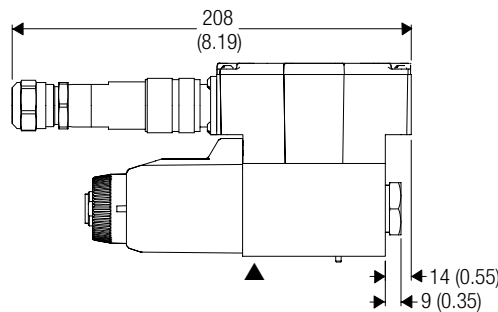

#### Warning

Valves with integral amplifiers are supplied with or without the metal 7-pin plug. The Vickers™ plug, part no. 934939, must be correctly fitted to ensure that the EMC rating and IP67 rating are achieved. The plug retaining nut must be tightened with a torque of 2-2,5 Nm (1.5-2.0 lbf ft) to effect a proper seal.

▲ Mounting surface seals supplied

† Note: Bleed screw locations. Air bleed: torque to 6,5-7,5 Nm (57-66 lbf ft).

**NOTE:** For optimum valve operation, bleed the air from the proportional solenoids at initial start-up. This may be done as follows:

- Remove the bleed screws until no bubbles appear and then reinstall bleed screws, or...
  - Remove both bleed screws, and use a standard oil can nozzle to pump fluid in one side until it flows, free of air bubbles, out the other side. Reinstall screws.
- If there is no inherent back pressure in the tank port of the circuit, do not allow the tank line to empty. This may be prevented by installing a check valve in the tank line. The cracking pressure of the check valve should be in the range of 1.5-3 bar (22-45 psi).

## Installation Dimensions in mm (inches)

### Parallel Flow Path Module

Size 03 Parallel-Flow-Path Module  
KDGMA-3-616265-1\*

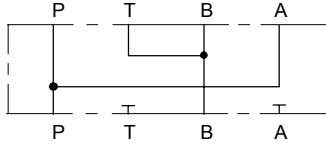

Typically used for doubling effective flow capability of single solenoid proportional valves (throttle valves).

▲ A, T<sub>A</sub> and T<sub>B</sub> ports at subplate face are blind holes fitted with O-seals.

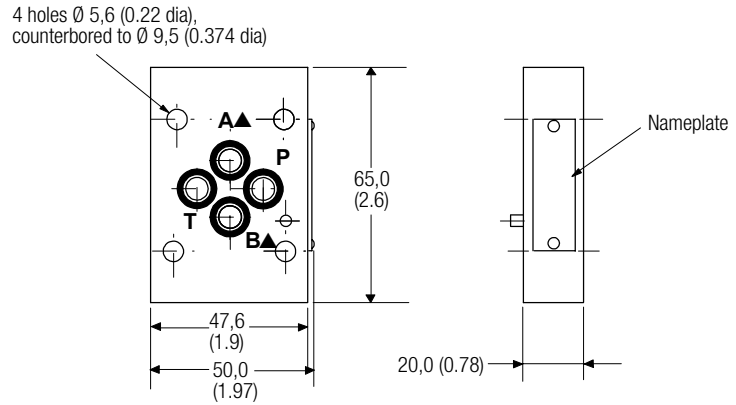

## Subplates and Mounting Surfaces

### General Description

If a subplate is not used a machined pad must be provided for valve mounting. Pad must be flat within 0,0127 mm (.0005 inch) and smooth within 1,6 µm (63 microinch). Mounting bolts, when provided by customer, should be ISO 898 class 12.9 or better.

### Dimensional Tolerances

Dimensional tolerance on interface drawings is ±0,2 mm (±0.008") except where otherwise stated. ISO 4401 specifies inch conversion to ±0.01".

### Conversion from Metric

ISO 4401 gives dimensions in mm. Inch conversions are accurate to 0.01" unless otherwise stated.

### Mounting Bolt Tappings

ISO 4401 gives metric thread tappings. Alternate UNC tappings are recommendations that allow these plates and associated valves to be used up to their maximum pressures, when using recommended Vickers™ bolt kits, or bolts of an equivalent strength. It is recommended that customers' own manifold blocks for UNC bolts should be tapped to the minimum depths given in the footnotes.

### Subplates

Description and Mass kg (lb)	Functional Symbol	Model Code	Max. Pressure
Single-station subplate; Rear ports P, T, A, B Cast iron 1,3 (2.9)		KDGM-3-1*-R▲ KDGVM-3-676803-1* (SAE/UNF ports)	250 bar (3600 psi)

\* Design number subject to change. No change of installation dimensions for design numbers 10 to 19 or 21 to 29 inclusive.

▲ "S" suffix = SAE/UNC ports and/or UNC fixing bolt tappings and/or orifice plugs as appropriate.  
"R" suffix = BSPF and/or metric fixing bolt tappings and/or orifice plugs as appropriate.



## Installation Dimensions in mm (inches)

### Single-Station Subplates

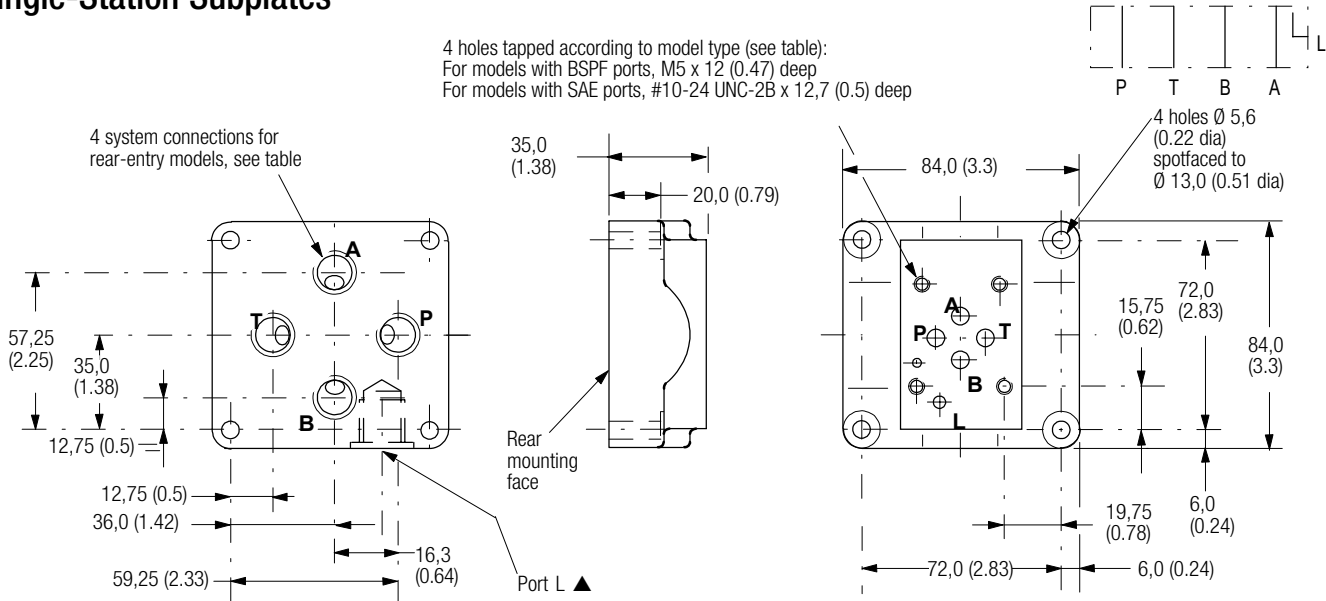

### Port Threads

Model	Ports P, T, A, B	Port L
<b>BSPF ports/M5 mounting bolts:</b>		
KDGM-3-1*-R	Rear $G^{3/8}$ " ( $3/8$ " BSPF) x 12,0 (0.47) deep	$G^{1/8}$ " ( $1/8$ " BSPF) x 12,0 (0.47) deep
<b>SAE ports/#10-24 UNC mounting bolts:</b>		
KDGM-3-676803-1*	Rear $3/4$ "-16 UNF-2B x 14,3 (0.56) deep (SAE)	$7/16$ "-20 UNF-2B x 11,6 (0.46) deep (SAE)

▲ 11,5 (0.45) from rear mounting face to port centerline.

### Mounting Surface to ISO 4401 (Size 03)

This interface conforms to:  
 ISO 4401-03-02-0-94  
 plus location pin hole  
 ANSI/B93.7M (and NFPA) size 03  
 CETOP R35H4.2-4-03, plus location pin hole  
 DIN 24340 Form A6 plus location pin hole

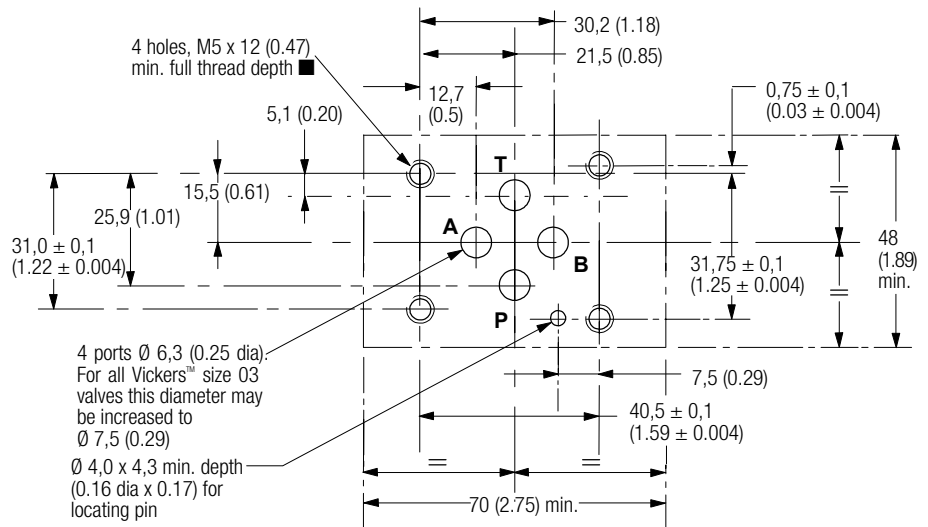

■ #10-24 UNC-2B optional.

## Electrical Information

### Block Diagram

KBD/TG4V-3

#### Command Signals and Outputs

7-pin plug			Flow direction	
Command = Volts ( $\pm 10V$ )	Pin D	Pin E		
	Positive	OV	P to A	
	OV	Negative		
	$V_D - V_E = \text{Positive}$			
	Negative	OV	P to B	
	OV	Positive		
$V_D - V_E = \text{Negative}$				

Command =	Pin D	Pin E	Pin B	Flow direction
Current (4-20 mA)	more than 12 mA	Current GND	Current return	P to A
	less than 12 mA	Current GND	Current return	P to B

#### Wiring

Connections must be made via the 7-pin plug mounted on the amplifier. See this leaflet and Installation Wiring Practices for Vickers™ Electronic Products leaflet 2468. Recommended cable sizes are:

#### Power cables:

For 24V supply:  
 0,75 mm<sup>2</sup> (18 AWG) up to 20m (65 ft)  
 1,00 mm<sup>2</sup> (16 AWG) up to 40m (130 ft)

#### Signal cables:

0,50 mm<sup>2</sup> (20 AWG)

#### Screen (shield):

A suitable cable would have 7 cores, a separate screen for the signal wires and an overall screen. Cable outside diameter 8,0-10,5 mm (0.31-0.41 inches)  
 See connection diagram on next page.

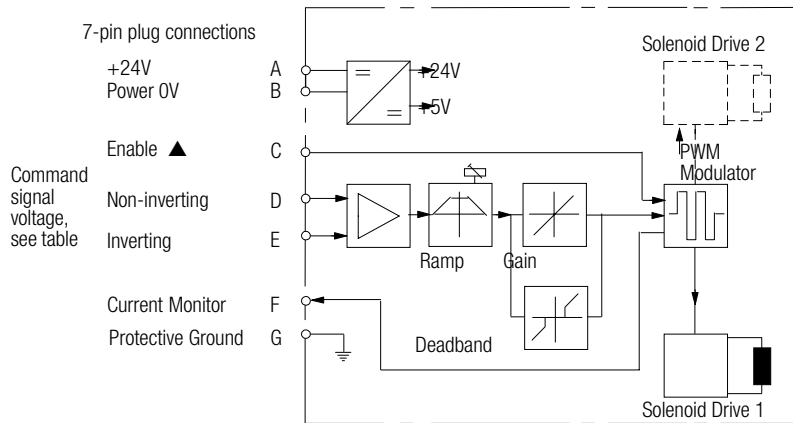

▲ In valves with PH7 or PR7 type electrical connection.



#### Warning

All power must be switched off before connecting or disconnecting any plugs.

## Typical Connection Arrangements

### Wiring Connections

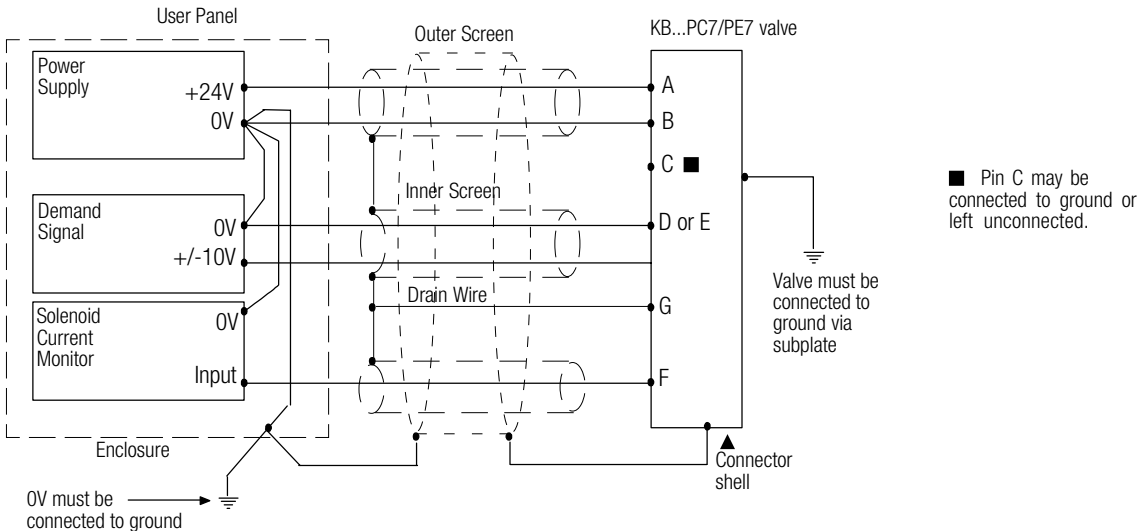

### Wiring Connections for Valves with “Enable” Feature

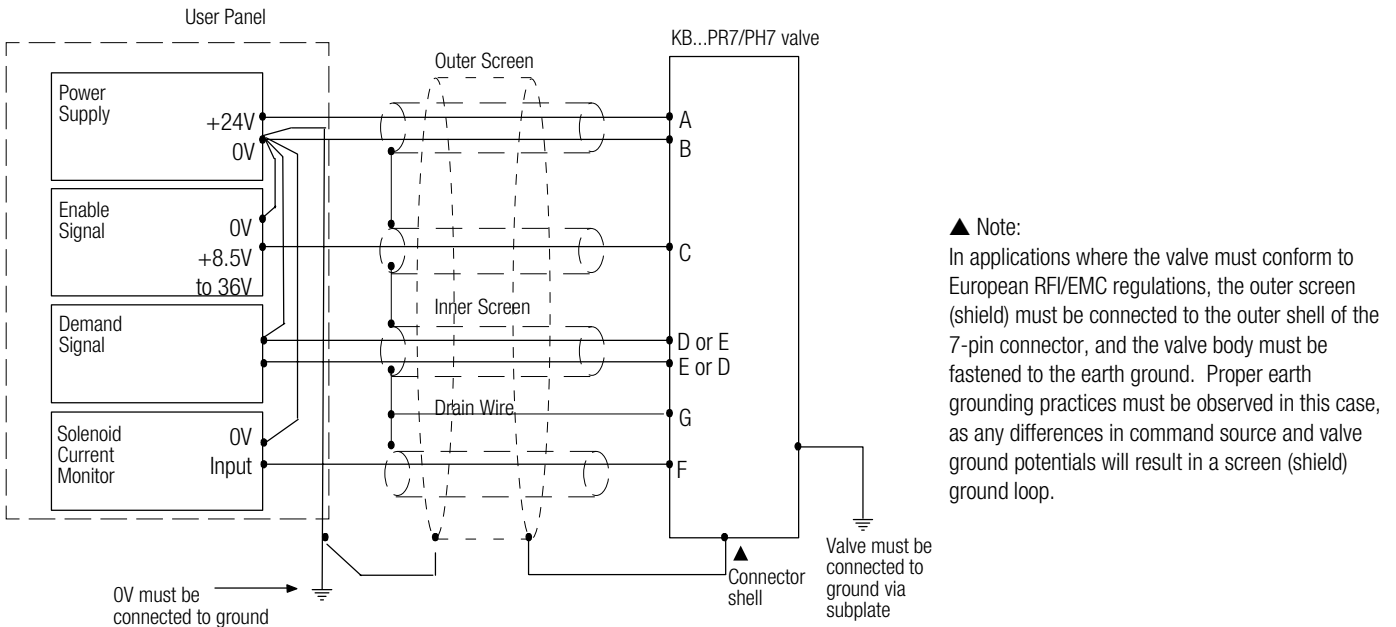

### Warning

#### Electromagnetic Compatibility (EMC)

It is necessary to ensure that the valve is wired up as above. For effective protection the user electrical cabinet, the valve subplate or manifold and the cable screens should be connected to efficient ground points. The metal 7-pin connector part no. 934939 should be used for the integral amplifier. In all cases both valve and cable should be kept as far away as possible from any sources of electromagnetic radiation such as cables carrying heavy current, relays and certain kinds of portable radio transmitters, etc. Difficult environments could mean that extra screening may be necessary to avoid the interference. It is important to connect the 0V lines as shown above. The multi-core cable should have at least two screens to separate the demand signal and monitor output from the power lines.

The enable line to pin C should be outside the screen which contains the demand signal cables.

## Application Data

### Fluid Cleanliness

Proper fluid condition is essential for long and satisfactory life of hydraulic components and systems. Hydraulic fluid must have the correct balance of cleanliness, materials and additives for protection against wear of components, elevated viscosity and inclusion of air.

Recommendations on contamination control methods and the selection of products to control fluid condition are included in publication 9132 or 561, "Guide to Systemic Contamination Control". The book also includes information on the concept of "ProActive Maintenance". The following recommendations are based on ISO cleanliness levels at 2 µm, 5 µm and 15 µm.

For products in this catalog the recommended levels are:

0 to 70 bar (1000 psi).....	18/16/13
70 + bar (1000 + psi).....	17/15/12

Vickers™ products, as any components, will operate with apparent satisfaction in fluids with higher cleanliness codes than those described. Other manufacturers will often recommend levels above those specified.

Experience has shown, however, that life of any hydraulic components is shortened in fluids with higher cleanliness codes than those listed above. These codes have been proven to provide a long trouble-free service life for the products shown, regardless of the manufacturer.

### Hydraulic Fluids

Materials and seals used in these valves are compatible with antiwear hydraulic oils, and with non-alkyl-based phosphate esters.

The extreme operating viscosity range is 500 to 13 cSt (2270 to 70 SUS) but the recommended running range is 54 to 13 cSt (245 to 70 SUS).

### Installation

The proportional valves in this catalog can be mounted in any attitude, but it may be necessary in certain demanding applications, to ensure that the solenoids are kept full of hydraulic fluid. Good installation practice dictates that the tank port and any drain port are piped so as to keep the valves full of fluid once the system start-up has been completed.

### Mounting Bolt Kits

BK02-156493M (metric)

BK590716 (inch)

*If not using recommended Vickers™ bolt kits, bolts used should be to ISO 898, 12.9 or better.*

### Seal Kit

02-351111

### Plugs

7-pin plug (metal) ..... 934939

7-pin plug (plastic) ..... 694534

(Metal plug must be used for full EMC protection)

**Note:** An alternative metal connector which gives EMC protection but not IP67 rating is available from ITT-Cannon, part number CA06-COM-E-14S-A7-P.

### Service Information

The products from this range are preset at the factory for optimum performance; disassembling critical items would destroy these settings. It is recommended that if any mechanical or electronic repair is necessary, valves should be returned to the nearest Eaton Hydraulics repair center. The products will be refurbished as necessary and retested to specification before return.

Field repair is restricted to the replacement of the seals.



Information contained in this catalog is accurate as of the publication date and is subject to change without notice. Performance values are typical values. Customers are responsible for selecting products for their applications using normal engineering methods.

**Eaton Hydraulics**

14615 Lone Oak Road  
Eden Prairie, MN 55344  
Telephone: 952 937-7254  
Fax: 952 974-7130  
www.eatonhydraulics.com

46 New Lane, Havant  
Hampshire PO9 2NB  
England  
Telephone: (44) 23 9248 6451  
Fax: (44) 23 9248 7110



**Quality System Certified**  
Products in this catalog are  
manufactured in an  
ISO-9001-certified site.

Copyright Eaton Corporation, 2001  
All rights reserved.

Printed in U.S.A.

11-05-5071-EN-01-01